

Used with permission from Larry Bosworth of the Pinewood Derby SuperSite. Many thanks to Larry for his permission to use these templates. Pinewood Derby SuperSite can be found at <http://www.inetworld.net/bosworth/>.

Good luck and good racing.

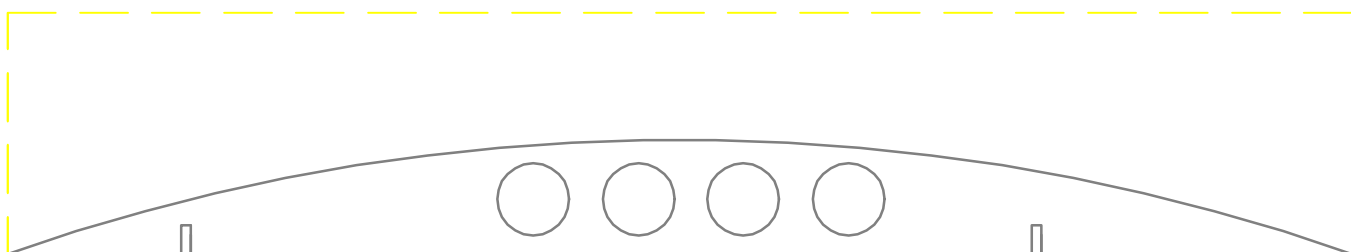

3/8" HOLES FOR WEIGHT

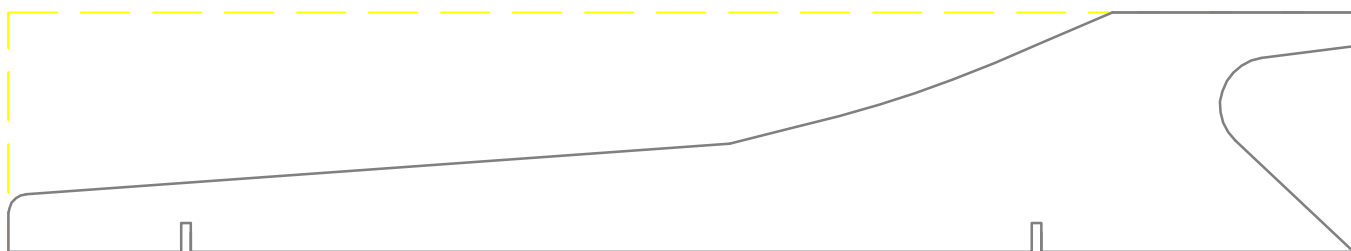
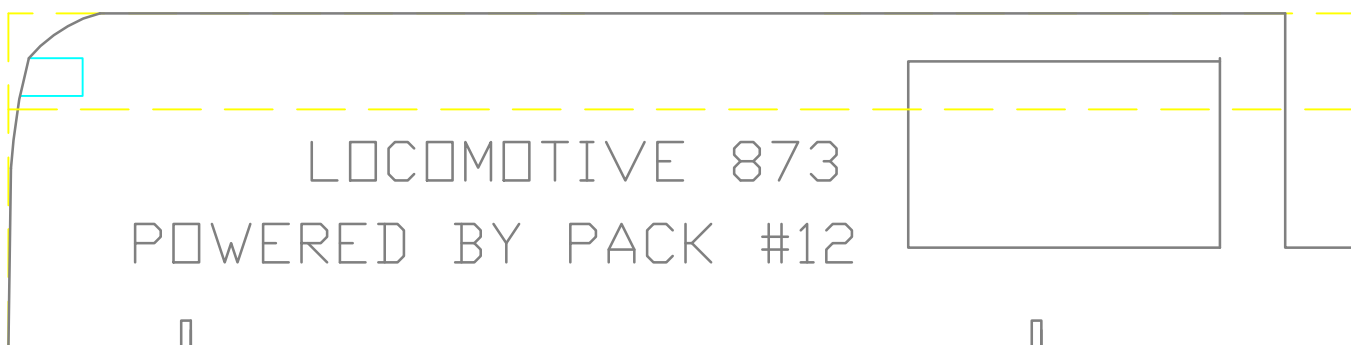

GLUE EXTRA WOOD TO BLOCK FOR REQUIRED HEIGHT

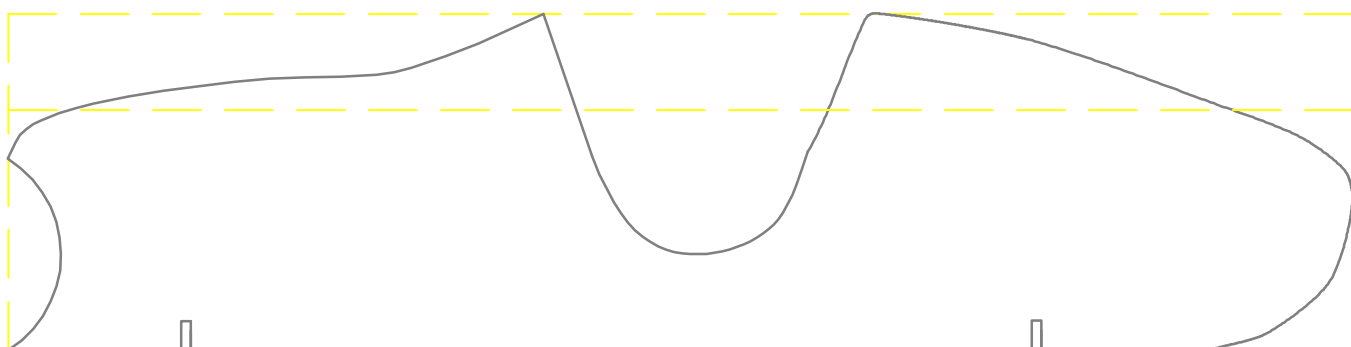

GLUE EXTRA WOOD TO BLOCK FOR REQUIRED HEIGHT

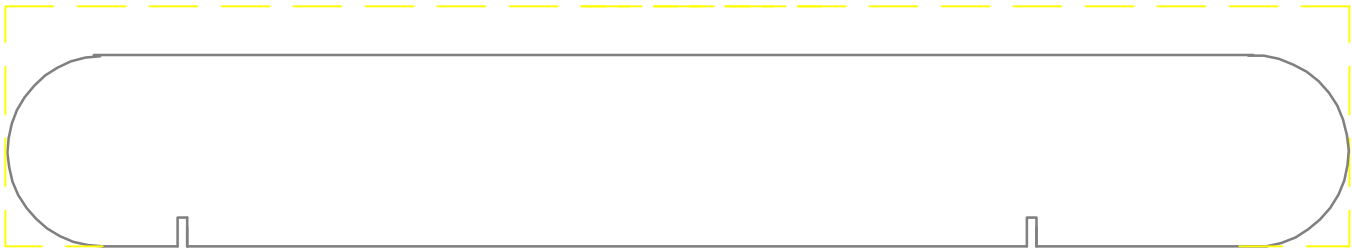
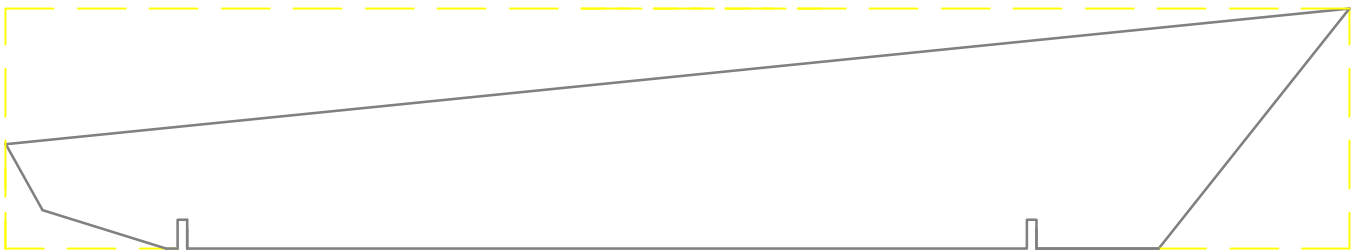
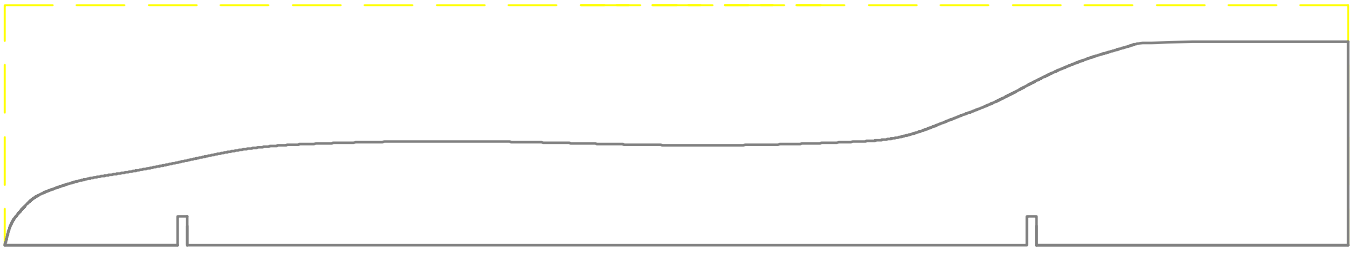

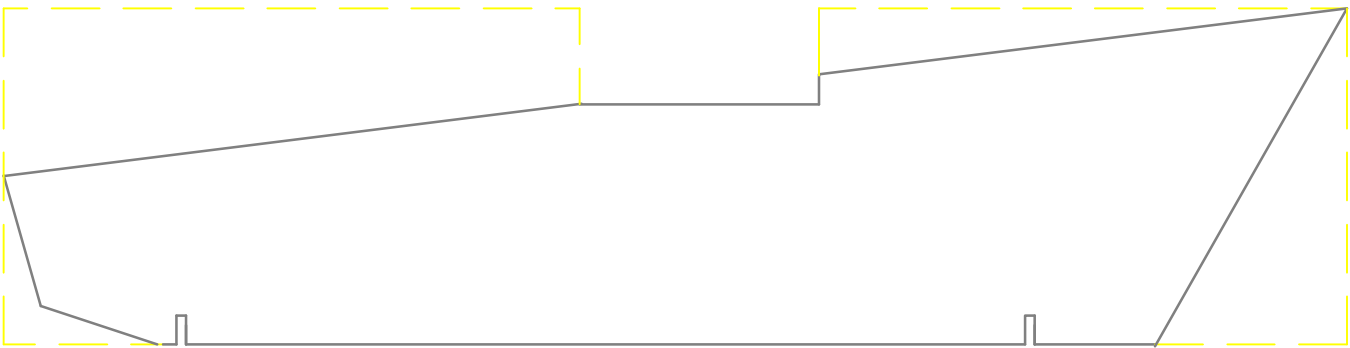
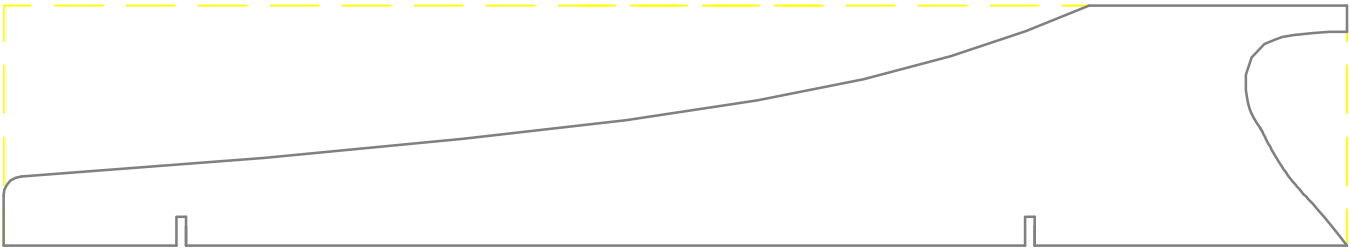
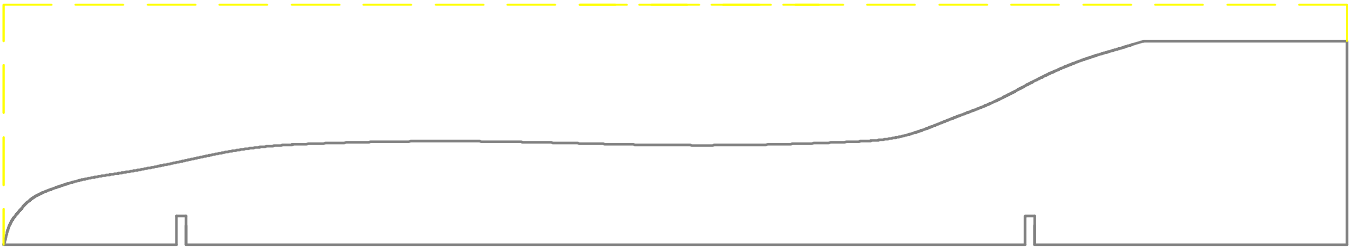

OLD STYLE BLOCK

MINIMOUSE – CUT PROFILE THEN SHAPE BODY

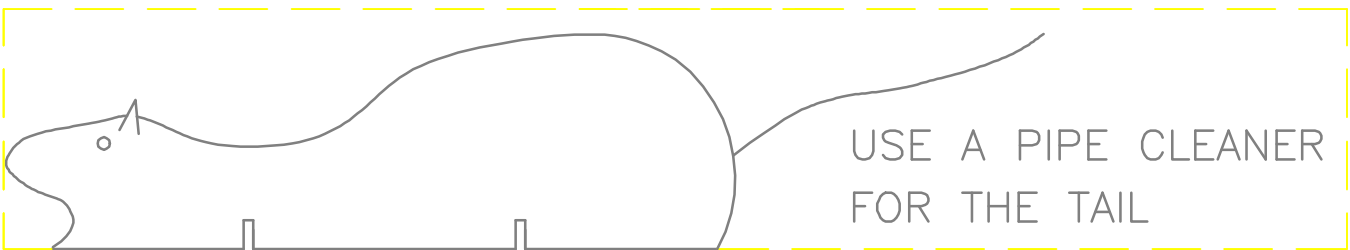

USE A PIPE CLEANER FOR THE TAIL

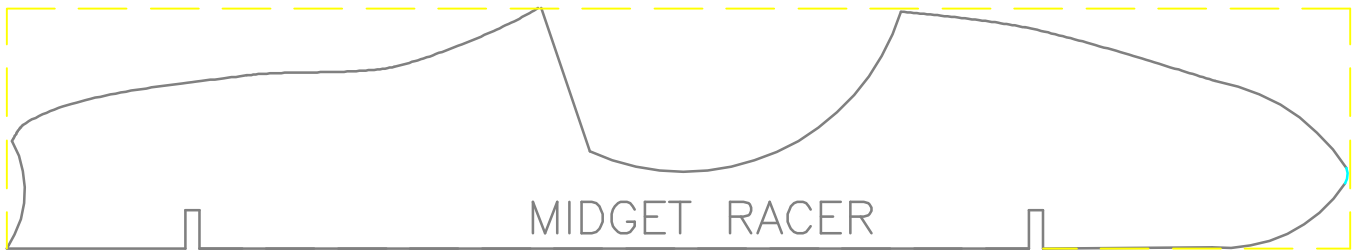
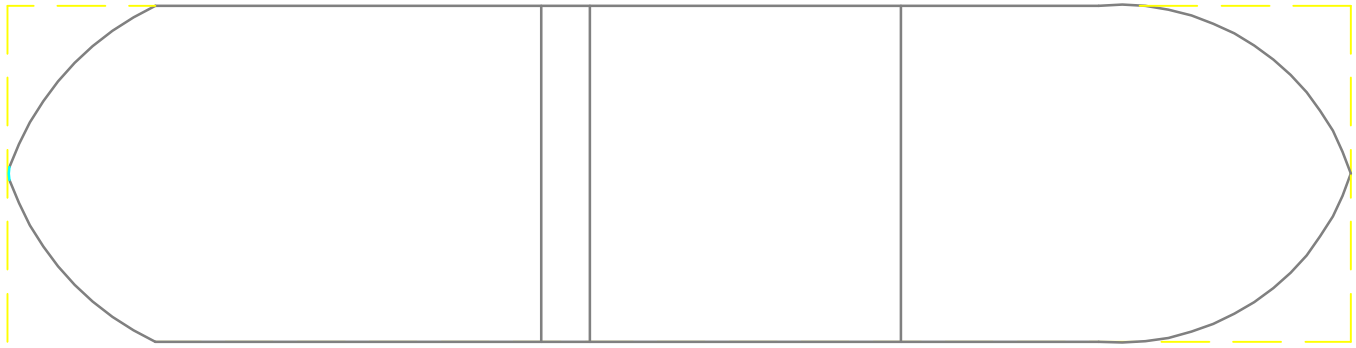

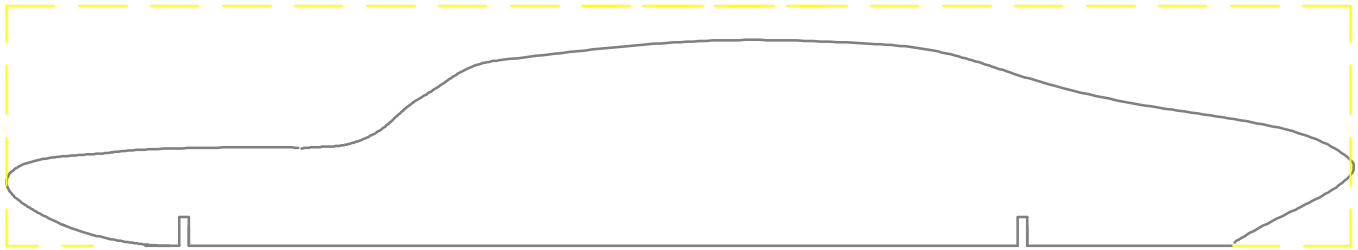
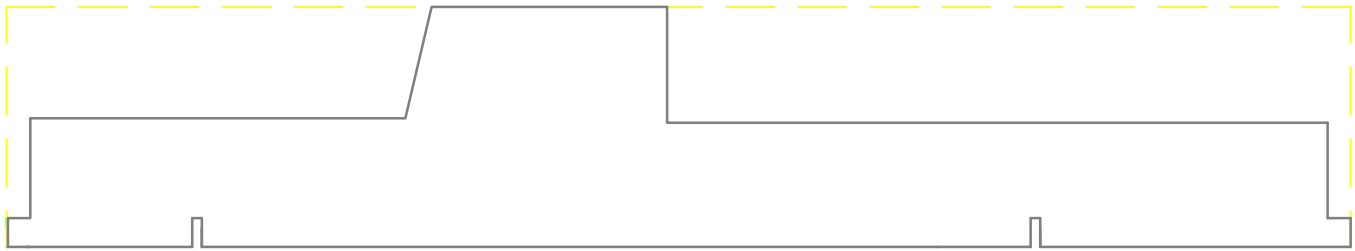
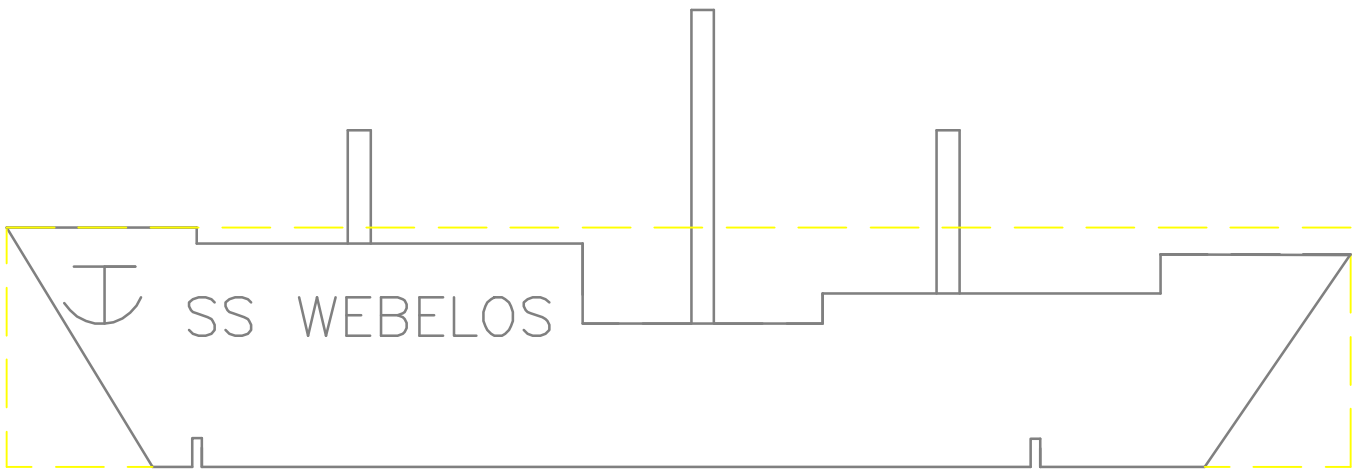
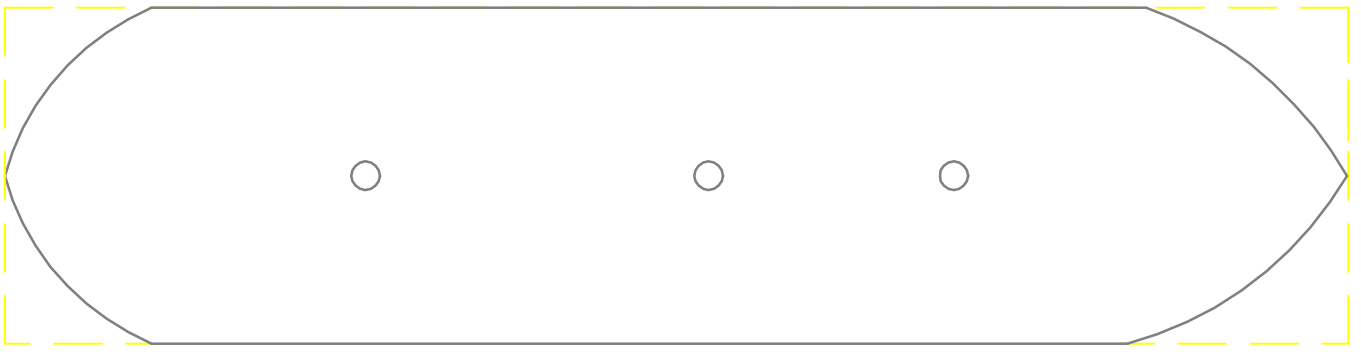

GLUE ON ROUNDED 1/2" DOWEL

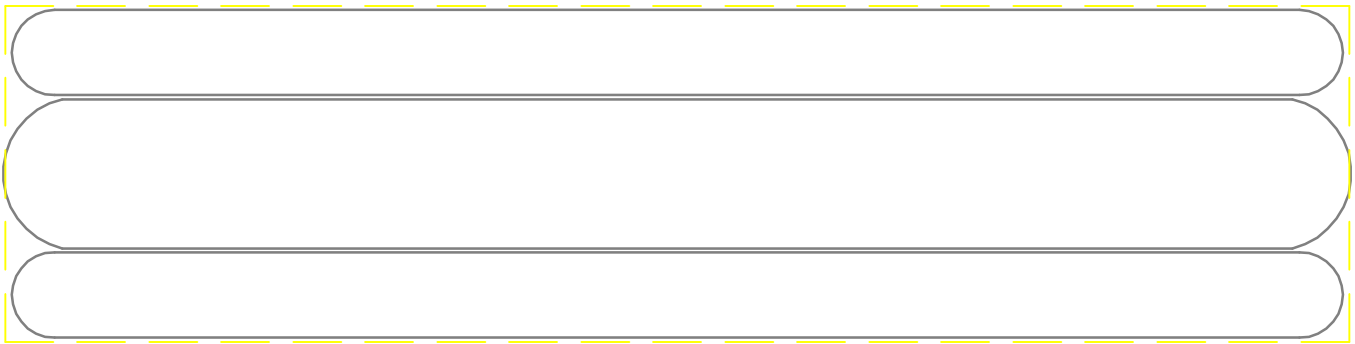
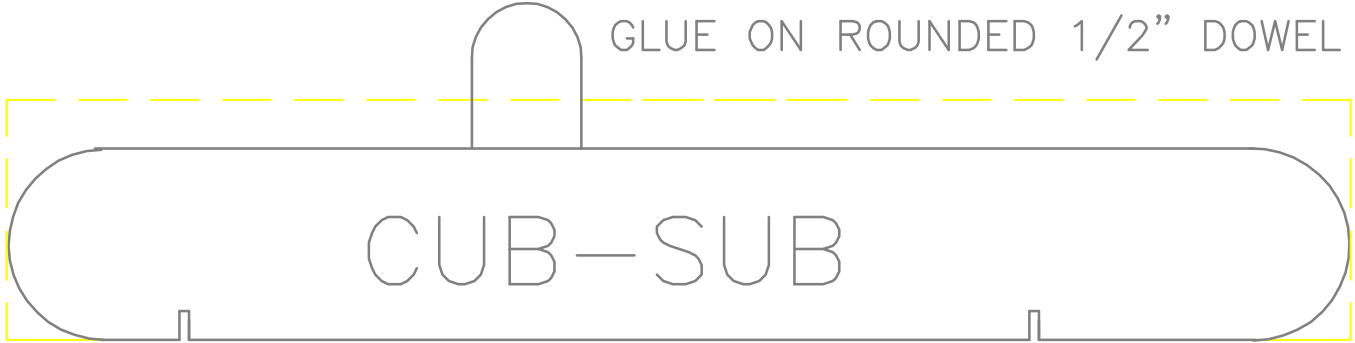

HOTDOGGER TOP VIEW

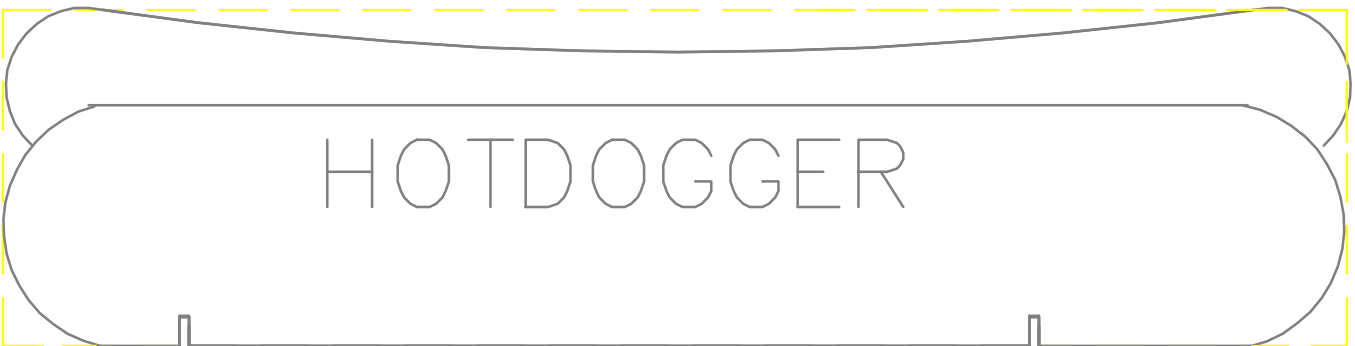

GLUE ADDITIONAL WOOD FOR HEIGHT

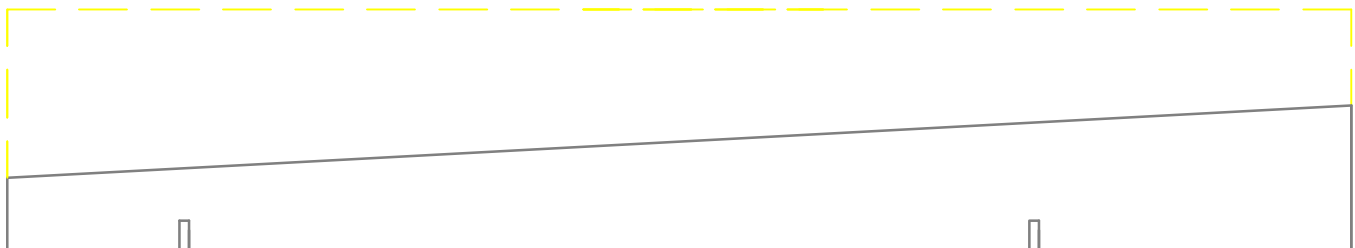

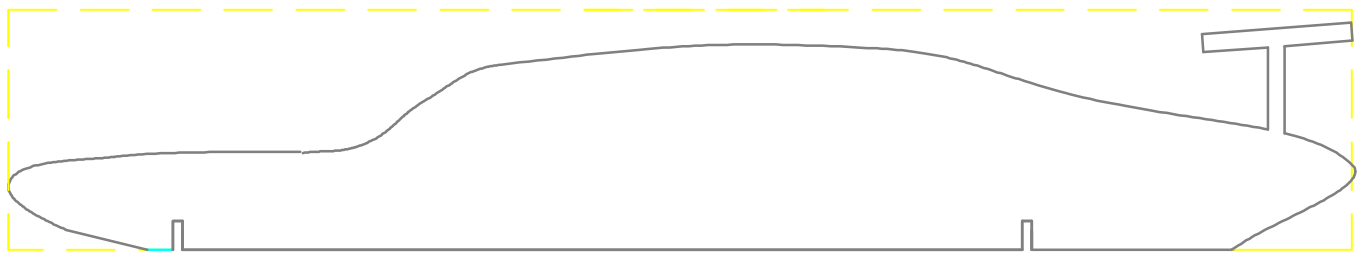
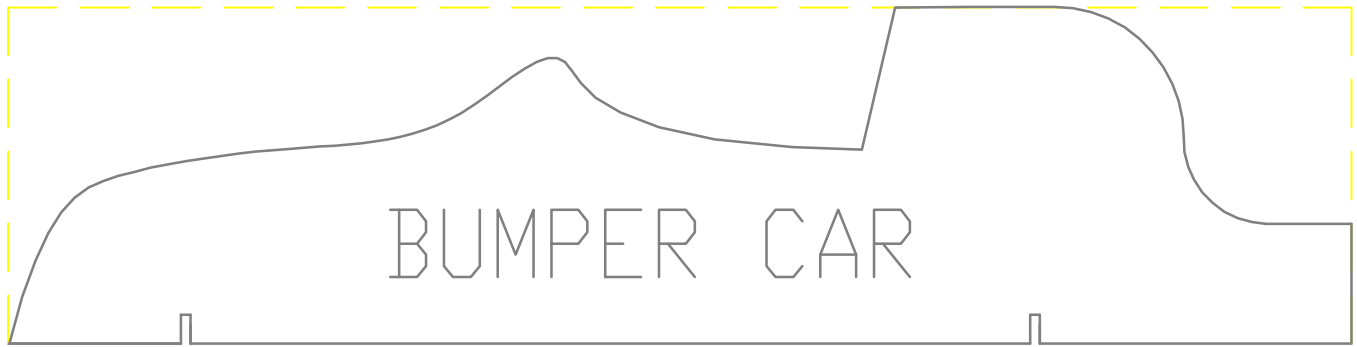

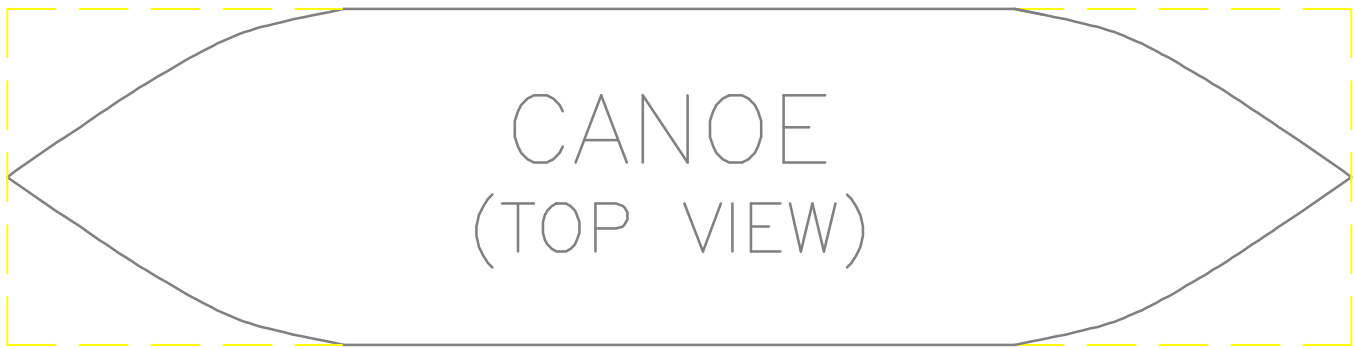
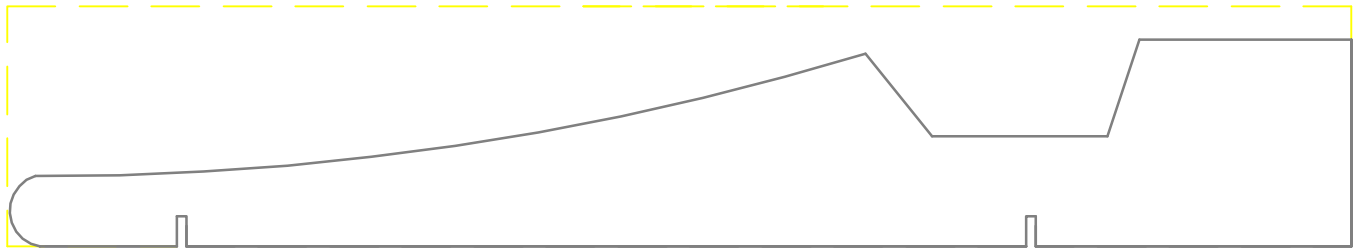
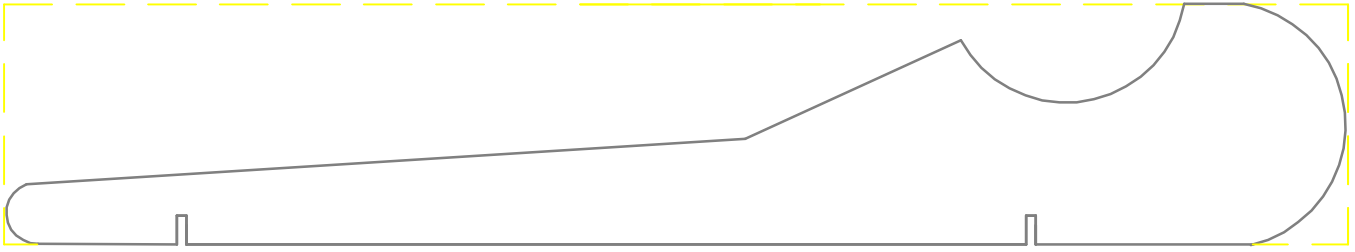

REQUIRES EXTRA HEIGHT

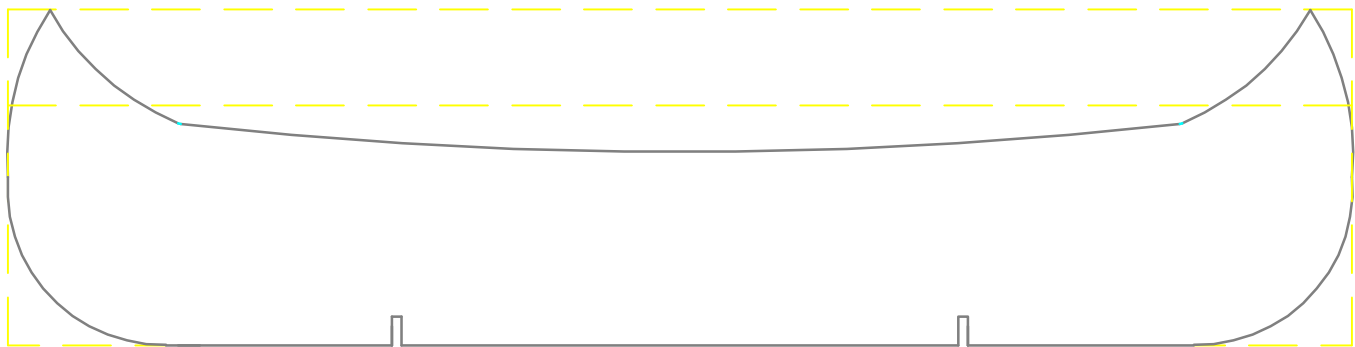

SHORTEN WHEELBASE

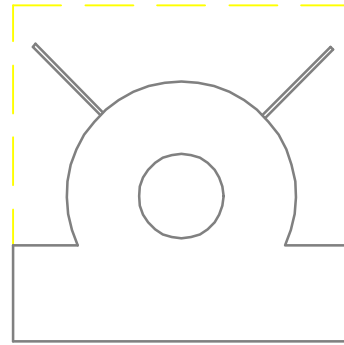
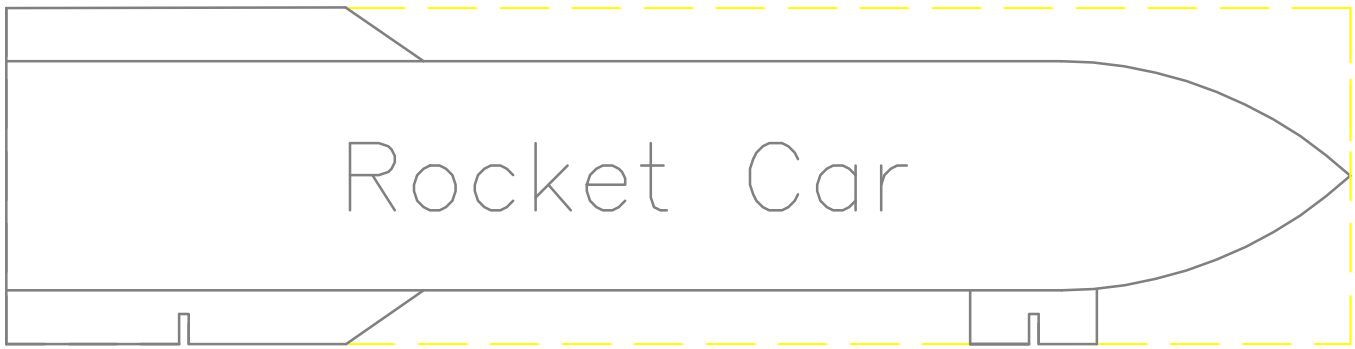

END VIEW

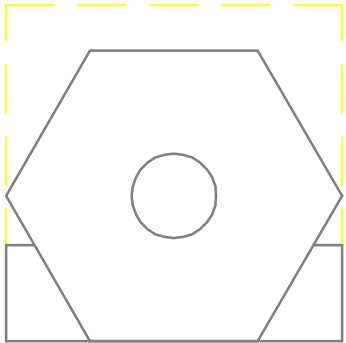

END VIEW

GLUE ADDITIONAL WOOD FOR THESE DESIGNS

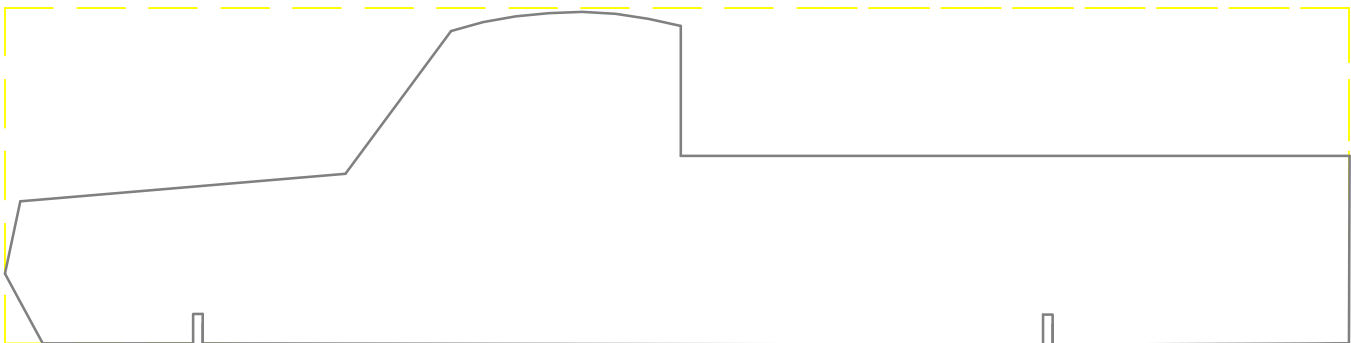
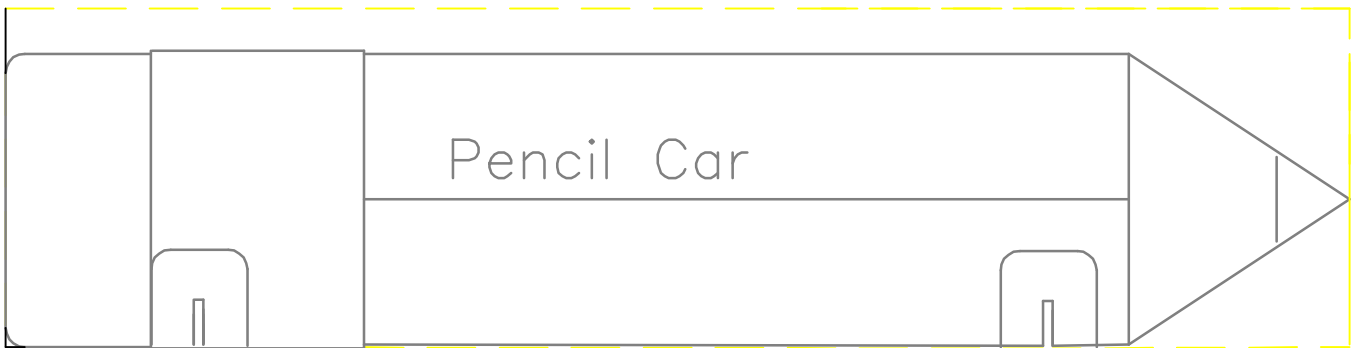

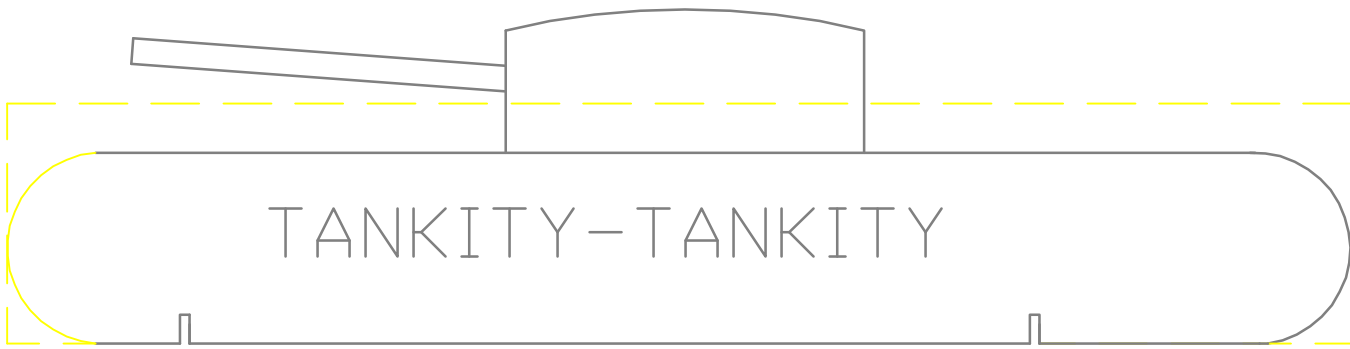

TANKITY-TANKITY

ADD WOOD FOR TURRET AND BARREL

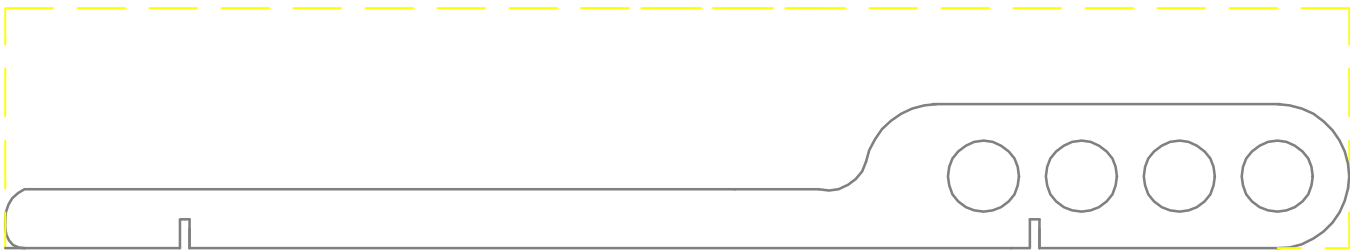

ADD WEIGHT IN 3/8" HOLES

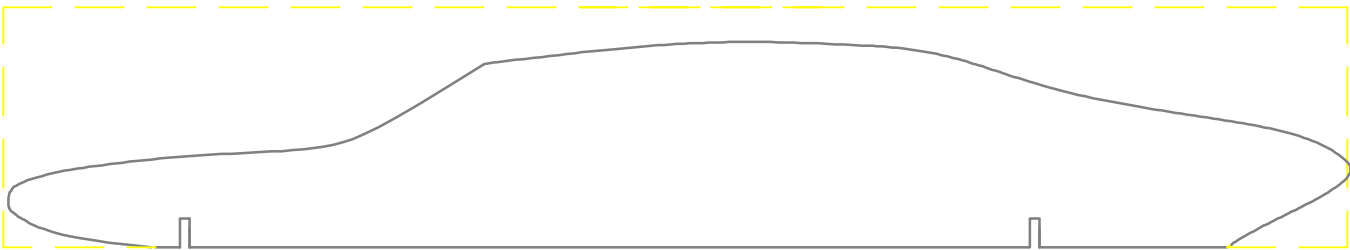

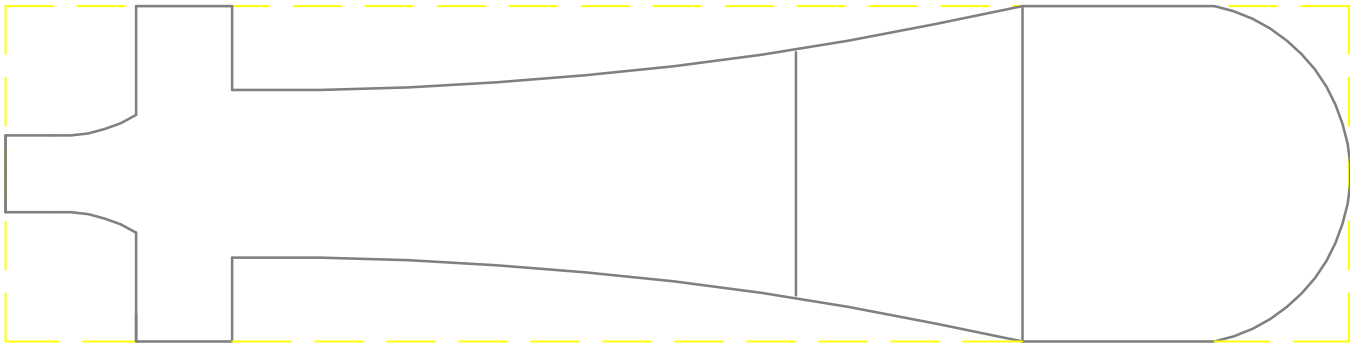
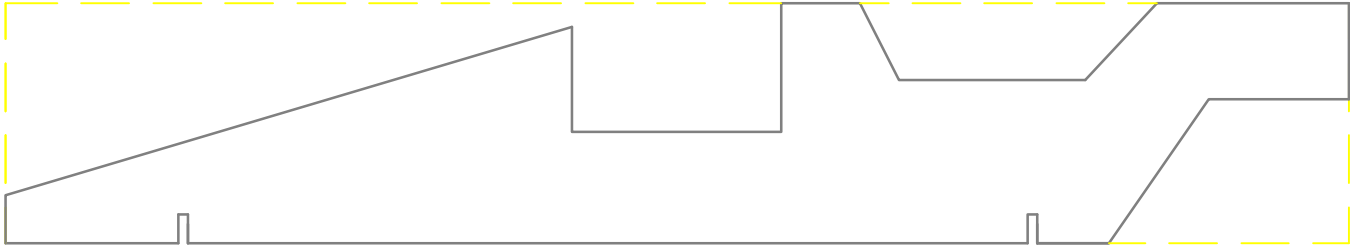

"DRAGSTER TOP VIEW"

"DRAGSTER"

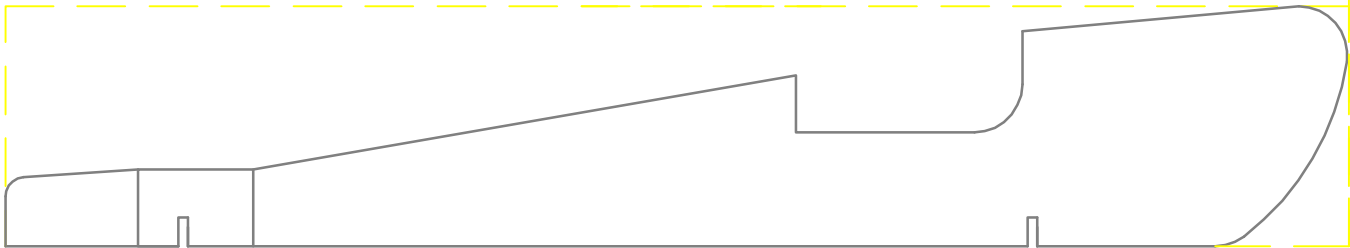

"SLOW SHORT STUFF"



ADD WEIGHT IN 3/8" HOLES